

Prepared by:

**Stephen R. Melchiori, PSM
1995 W. Barefoot Place
Vero Beach, Florida 32963**

**Return recorded original to:
Office of General Counsel
St. Johns River Water Management District
4049 Reid Street
Palatka, FL 32177**

**Note to Recording Clerk:
Please cross reference with
OR Book 3134 Page 2422**

**PARTIAL RELEASE OF REGULATORY CONSERVATION EASEMENT IN
EXCHANGE FOR SUBSTITUTE MITIGATION**

THIS PARTIAL RELEASE OF REGULATORY CONSERVATION EASEMENT IN EXCHANGE FOR SUBSTITUTE MITIGATION is entered into this ____ day of _____, 20____, by Lost Tree Preserve Owners Association, Inc., a Florida non-profit corporation whose address is 11300 U.S. 1, Suite 100, Palm Beach Gardens, FL 33408 ("Grantor"), and ST. JOHNS RIVER WATER MANAGEMENT DISTRICT, whose address is 4049 Reid Street, Palatka, Florida 32177 ("Grantee").

RECITALS:

WHEREAS, Grantor's predecessor in title, Lost Tree Preserve, LLC, a Florida limited liability company, executed and granted a Conservation Easement dated July 5, 2018, and recorded in Official Records of Indian River County in Book 3134, Page 2422 ("the Conservation Easement"), over certain real property situated, lying and being in Indian River County, Florida, as more particularly described therein, in accordance with District Permit No. 4-061-96932-2, ("Permit"); and

WHEREAS, Grantor has requested that the Grantee release a portion of the property subject to the Conservation Easement, as described in attached Exhibit "1."

WHEREAS, Grantee has agreed to release the portion of the property subject to the Conservation Easement described in the attached Exhibit "1" in exchange for mitigation of at least equivalent ecological value; and

WHEREAS, the parties intend to ratify the remainder of the Conservation Easement which is not released herein; and

WHEREAS, subsection 704.06(4), Florida Statutes, provides that the holder of a conservation easement may release that conservation easement to the holder of the fee interest.

NOW THEREFORE, in consideration of the above and the mutual covenants, terms, conditions and restrictions contained herein, and other valuable consideration, the receipt and sufficiency of which is hereby acknowledged, the parties agree as follows:

1. Release. Grantee hereby releases, terminates, discharges, and quit claims any and all interests, rights, privileges, and licenses in and to the property described in attached Exhibit "1." This Partial Release of Regulatory Conservation Easement in Exchange for Substitute Mitigation is binding upon and shall inure to the benefit of Grantor and its successors and assigns. This Partial Release of Regulatory Conservation Easement in Exchange for Substitute Mitigation applies specifically to the real property described in attached Exhibit "1."

2. Substitution. In Exchange for the release identified in Paragraph 1 herein, Grantor hereby grants to Grantee a conservation easement over the property described in attached Exhibit "2" ("the Property").

3. Reaffirmation. Except as specifically set forth herein, all provisions of the Conservation Easement shall remain unchanged and in full force and effect. The property described in the Conservation Easement is unaffected by this Partial Release of Regulatory Conservation Easement in Exchange for Substitute Mitigation and shall continue to be bound by the terms of said Conservation Easement.

4. Purpose. The purpose of this Partial Release of Regulatory Conservation Easement in Exchange for Substitute Mitigation is, in part, to assure that the Property will be retained forever in its existing natural condition and to prevent any use of the Property that will impair or interfere with the environmental value of the Property.

5. Prohibited Uses. Except for restoration, creation, enhancement, maintenance and monitoring activities, or surface water management improvements, which are permitted or required by the Permit, the following activities and uses are expressly prohibited on the Property:

(a) Construction or placing buildings, roads, signs, billboards or other advertising, utilities or other structures on or above the ground.

(b) Dumping or placing soil or other substance or material as landfill or dumping or placing of trash, waste or unsightly or offensive materials.

(c) Removing or destroying trees, shrubs, or other vegetation.

(d) Excavating, dredging or removing loam, peat, gravel, soil, rock or other material substances in such a manner as to affect the surface.

(e) Surface use, except for purposes that permit the land or water area to remain predominantly in its natural condition.

(f) Activities detrimental to drainage, flood control, water conservation, erosion control, soil conservation, or fish and wildlife habitat preservation.

(g) Acts or uses detrimental to such retention of land or water areas.

(h) Acts or uses detrimental to the preservation of the structural integrity or physical appearance of sites or properties of historical, architectural, archaeological, or cultural significance.

6. Reserved Rights. Grantor reserves unto itself, and its successors and assigns, all rights accruing from its ownership of the Property, including the right to engage in or permit or invite others to engage in all uses of the Property, that are not expressly prohibited herein and are not inconsistent with the purpose of this Partial Release of Regulatory Conservation Easement in Exchange for Substitute Mitigation.

7. Rights of Grantee. To accomplish the purposes stated herein, Grantor conveys the following rights to Grantee:

(a) To enter upon and inspect the Property in a reasonable manner and at reasonable times to determine if Grantor or its successors and assigns are complying with the covenants and prohibitions contained in this Partial Release of Regulatory Conservation Easement in Exchange for Substitute Mitigation.

(b) To proceed at law or in equity to enforce the provisions of this Partial Release of Regulatory Conservation Easement in Exchange for Substitute Mitigation and the covenants set forth herein, to prevent the occurrence of any of the prohibited activities set forth herein and require the restoration of areas or features of the Property that may be damaged by any activity inconsistent with this

Partial Release of Regulatory Conservation Easement in Exchange for Substitute Mitigation.

8. Grantee's Discretion. Grantee may enforce the terms of Partial Release of Regulatory Conservation Easement in Exchange for Substitute Mitigation at its discretion, but if Grantor breaches any term of this Partial Release of Regulatory Conservation Easement in Exchange for Substitute Mitigation and Grantee does not exercise its rights under this Partial Release of Regulatory Conservation Easement in Exchange for Substitute Mitigation, Grantee's forbearance shall not be construed to be a waiver by Grantee of such term, or of any subsequent breach of the same, or any other term of this Partial Release of Regulatory Conservation Easement in Exchange for Substitute Mitigation, or of any of the Grantee's rights under this Partial Release of Regulatory Conservation Easement in Exchange for Substitute Mitigation. No delay or omission by Grantee in the exercise of any right or remedy upon any breach by Grantor shall impair such right or remedy or be construed as a waiver. Grantee shall not be obligated to Grantor, or to any other person or entity, to enforce the provisions of this Partial Release of Regulatory Conservation Easement in Exchange for Substitute Mitigation.

9. Grantee's Liability. Grantor will assume all liability for any injury or damage to the person or property of third parties which may occur on the Property arising from Grantor's ownership of the Property. Neither Grantor, nor any person or entity claiming by or through Grantor, shall hold Grantee liable for any damage or injury to person or personal property which may occur on the Property.

10. Acts Beyond Grantor's Control. Nothing contained in this Partial Release of Regulatory Conservation Easement in Exchange for Substitute Mitigation shall be

construed to entitle Grantee to bring any action against Grantor for any injury to or change in the Property resulting from natural causes beyond Grantor's control, including, without limitation, fire, flood, storm and earth movement, or from any necessary action taken by Grantor under emergency conditions to prevent, abate or mitigate significant injury to the Property or to persons resulting from such causes.

11. Recordation. Grantor shall record this Partial Release of Regulatory Conservation Easement in Exchange for Substitute Mitigation in timely fashion in the Official Records of Indian River County, Florida, and shall rerecord it at any time Grantee may require to preserve its rights. Grantor shall pay all recording costs and taxes necessary to record this Partial Release of Regulatory Conservation Easement in Exchange for Substitute Mitigation in the public records. Grantor will hold Grantee harmless from any recording costs or taxes necessary to record this Partial Release of Regulatory Conservation Easement in Exchange for Substitute Mitigation in the public records.

12. Successors. The covenants, terms, conditions and restrictions of this conservation easement shall be binding upon, and inure to the benefit of the parties hereto and their respective personal representatives, heirs, successors and assigns and shall continue as a servitude running in perpetuity with the Property. Grantee will hold this Partial Release of Regulatory Conservation Easement in Exchange for Substitute Mitigation exclusively for conservation purposes. Grantee will not assign its rights and obligations under this Partial Release of Regulatory Conservation Easement in Exchange for Substitute Mitigation.

IN WITNESS WHEREOF, the parties have executed this Partial Release of Regulatory Conservation Easement in Exchange for Substitute Mitigation on the day and year first above written.

Signed, sealed and delivered in our presence as witnesses:

GRANTOR:
Lost Tree Preserve Owners Association, Inc.

Signature: Natalie Germano

Printed Name: Natalie Germano
Address: 1640 Twelve Oaks Way #304
NPB, FL 33408

By: [Signature]
Printed Name: Charles H. Stevens.
Title: President

Signature: Kathleen M. Garulli
Printed Name: Kathleen M. Garulli
Address: 2 Nogales Way, FSL, FL 34952

STATE OF FLORIDA
COUNTY OF Palm Beach

The foregoing instrument was acknowledged before me, by Charles H. Stevens, President of Lost Tree Preserve Owners Association, Inc. a Florida Corporation **by means of** **physical presence** or **online notarization**, this 14th day of May, 2024, by Charles H. Stevens, who did not take an oath.

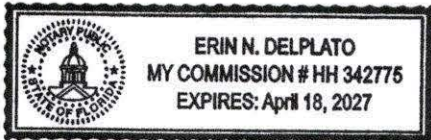

Erin N. DelPlato
Notary Public, State of Florida
at Large.

My Commission Expires:
April 18, 2027

Serial No. HH 342775

Personally known OR produced identification _____ Identification produced _____

Attest:

**GRANTEE: ST. JOHNS RIVER
WATER MANAGEMENT DISTRICT**



Name: Erin Preston
Title: General Counsel
St. Johns River Water
Management District
4049 Reid Street
Palatka, FL 32217-2529

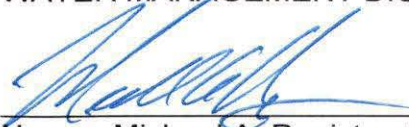

Name: Michael A. Register, P.E.
Title: Executive Director
St. Johns River Water
Management District
4049 Reid Street
Palatka, FL 32177-2529

[SEAL]



STATE OF FLORIDA
COUNTY OF PUTNAM

The foregoing instrument was acknowledged before me, **by means of physical presence or online notarization**, this 6th day of May, 2024, by Michael A. Register, P.E., the Executive Director of the St. Johns River Water Management District, a public body existing under Chapter 373, Florida Statutes, on behalf of the District. He is personally known to me.

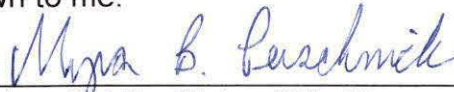

Notary Public, State of Florida
at Large.

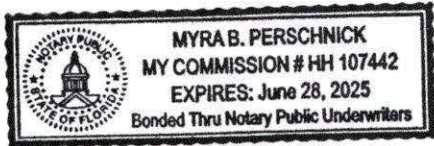

My Commission Expires:

June 28, 2025

Serial No. HH 107442

JOINDER AND SUBORDINATION OF INDIAN RIVER COUNTY AND
THE INDIAN RIVER COUNTY MOSQUITO CONTROL DISTRICT

Indian River County and the Indian River County Mosquito Control District join in the execution of this Partial Release of Regulatory Conservation Easement in Exchange for Substitute Mitigation and acknowledge and confirm that rights granted under the plat dedications to the County and District with respect to Tract C, Lost Tree Preserve Phase I as per plat thereof recorded in Plat Book 30, Page 1 are subject and subordinate to the terms and conditions of the Partial Release of Regulatory Conservation Easement in Exchange for Substitute Mitigation described herein as amended only as to that portion of Tract C described in Exhibit 2 of the foregoing Partial Release of Regulatory Conservation Easement in Exchange for Substitute Mitigation.

IN WITNESS WHEREOF, this Joinder and Subordination is executed by the undersigned on this 15 day of May, 2024.

Attest:

Indian River County

By: S. Burroughs
Print Name: Sherry Burroughs

STATE OF FLORIDA
COUNTY OF INDIAN RIVER

The foregoing instrument was acknowledge by means of personally present or by online notarization, this 15 day of May, 2024, by Johanna Avril as Notary, on behalf of Indian River County, who is personally known to me or who has produced a driver's license as identification.

NOTARY SEAL



Johanna Avril
Print Name: Johanna Avril
My Commission Expires: 3/11/2025

IN WITNESS WHEREOF, the Board joins in and subordinates its interest to this Partial Release of Regulatory Conservation Easement in Exchange for Substitute Mitigation Agreement as of the date approved below.

BOARD OF COUNTY COMMISSIONERS
INDIAN RIVER COUNTY, FLORIDA

BY: _____
Susan Adams, Chairman

BCC Approved: _____

Attest: Ryan L. Butler, Clerk of Court and
Comptroller

By: _____
Deputy Clerk

Approved as to form and legal sufficiency

William K. DeBaal
County Attorney

Approved:

By _____
John A. Titkanich, Jr.
County Administrator

Exhibit 1

(the release parcel)

Area to be removed from the Conservation Easement

Parcel A

A portion of Tract M, Lost Tree Preserve PD, Phases 2 and 3, as recorded in Plat Book 31, Pages 69 thru 76, Public Records of Indian River County, Florida; A portion of Said Tract M is included in the Conservation Easement recorded in Official Record Book 3134, Page 2422, Public Records of Indian River County, Florida. Begin at the southwest corner of said Tract M, thence, N14°15'26"W, along the west line of said Tract M, for a distance of 8.07'; thence, S83°36'51"E, for a distance of 22.95'; thence, S89°32'09"E, for a distance of 140.52'; thence, N89°41'00"E, for a distance of 353.50'; thence, N88°56'13"E, for a distance of 139.51'; thence, N81°12'38"E, for a distance of 30.82'; thence, S86°13'19"E, for a distance of 33.09'; thence, S88°42'22"E, for a distance of 135.06'; thence, N86°23'09"E, for a distance of 19.32'; thence, S88°46'23"E, for a distance of 10.17; thence, S75°08'25"E, for a distance of 7.63' to a point on the south line of said Tract M; thence, along the south line of said tract M, S89°32'12"W, for a distance of 889.68' to the point of beginning. Said parcel contains 2,770 square feet more or less.

Parcel B

A portion of Tract M, Lost Tree Preserve PD, Phases 2 and 3, as recorded in Plat Book 31, Pages 69 thru 76, Public Records of Indian River County, Florida; A portion of Said Tract M is included in the Conservation Easement recorded in Official Record Book 3134, Page 2422, Public Records of Indian River County, Florida. Commence at the northwest corner of said Tract M, thence, N89°21'19"E, along the north line of said Tract M, for a distance of 105.50' to the point of beginning for the herein described parcel of land; thence, S87°45'56"E, for a distance of 12.60'; thence, N89°57'11"E, for a distance of 56.00'; thence, S89°52'39"E, for a distance of 48.00'; thence, S87°09'18"E, for a distance of 64.12'; thence, S87°44'00"E, for a distance of 105.14'; thence, N88°50'33"E, for a distance of 109.91'; thence, N85°23'04"E, for a distance of 103.08'; thence, N87°49'46"E, for a distance of 44.52'; thence, S86°13'59"E, for a distance of 113.10'; thence, N82°14'05"E, for a distance of 50.89; thence, N78°42'58"E, for a distance of 22.69' to a point on the north line of said Tract M; thence, along the north line of said Tract M, S89°21'19"W, for a distance of 728.38' to the point of beginning.

Parcel C

A portion of Tract M, Lost Tree Preserve PD, Phases 2 and 3, as recorded in Plat Book 31, Pages 69 thru 76, Public Records of Indian River County, Florida; A portion of Said Tract M is included in the Conservation Easement recorded in Official Record Book 3134, Page 2422, Public Records of Indian River County, Florida. Commence at the northwest corner of said Tract M, thence, N89°21'19"E, along the north line of said Tract M, for a distance of 852.32' to the point of beginning for the herein described parcel of land; thence, S78°30'11"E, for a distance of 16.13'; thence, N83°54'14"E, for a distance of 35.70' to a point on the north line of said Tract M; thence, along the north line of said Tract M, S89°21'19"W, for a distance of 51.30' to the point of beginning.



Parcel D

A portion of Tract M, Lost Tree Preserve PD, Phases 2 and 3, as recorded in Plat Book 31, Pages 69 thru 76, Public Records of Indian River County, Florida; A portion of Said Tract M is included in the Conservation Easement recorded in Official Record Book 3134, Page 2422, Public Records of Indian River County, Florida. Commence at the northwest corner of said Tract M, thence, N89°21'19"E, along the north line of said Tract M, for a distance of 1,171.48' to the point of beginning for the herein described parcel of land; thence, S84°04'40"E, for a distance of 16.71'; thence, N83°57'25"E, for a distance of 20.32' to a point on the north line of said Tract M; thence, along the north line of said Tract M, S89°21'19"W, for a distance of 36.83' to the point of beginning.

Parcel E

A portion of Tract M, Lost Tree Preserve PD, Phases 2 and 3, as recorded in Plat Book 31, Pages 69 thru 76, Public Records of Indian River County, Florida; A portion of Said Tract M is included in the Conservation Easement recorded in Official Record Book 3134, Page 2422, Public Records of Indian River County, Florida. Commence at the northwest corner of said Tract M, thence, N89°21'19"E, along the north line of said Tract M, for a distance of 1,256.98' to the point of beginning for the herein described parcel of land; thence, S84°59'07"E, for a distance of 34.77'; thence, N82°59'32"E, for a distance of 30.94' to a point on the north line of said Tract M; thence, along the north line of said Tract M, S89°21'19"W, for a distance of 65.35' to the point of beginning.

Said parcels B, C, D and E contain 4,492 square feet more or less.



Stephen R. Melchiori, PSM
Florida Registration Number 5127



TRACT M

LOST TREE PRESERVE, PD
PHASES 2 AND 3, AS RECORDED
IN PLAT BOOK 31, PAGES 69 THRU 76
PUBLIC RECORDS OF INDIAN RIVER
COUNTY, FLORIDA

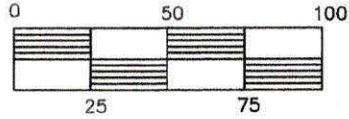
MATCH LINE



WEST LINE
OF TRACT M

S83° 36' 51"E
22.95'

S89° 32' 09"E
140.52'

N89° 41' 00"E
353.50'

N14° 15' 26"W
8.07'

SOUTH LINE OF TRACT M

S89° 32' 12"W
889.68'

POINT OF BEGINNING PARCEL A
SW CORNER OF TRACT M

65TH STREET

PARCEL A SHEET 1 OF 2



Stephen R. Melchiori
Stephen R. Melchiori, PSM
Florida Registration Number 5127
Note: Sketch of Description, not a survey

MATCH LINE

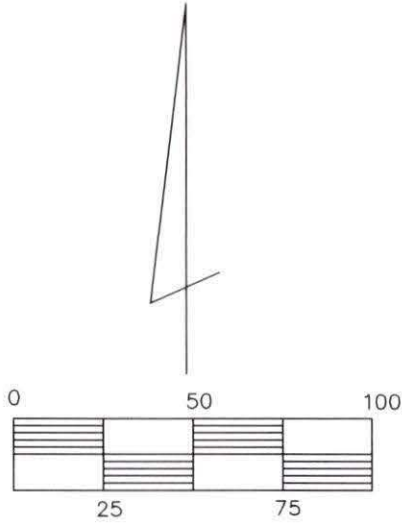

TRACT M

LOST TREE PRESERVE, PD
PHASES 2 AND 3, AS RECORDED
IN PLAT BOOK 31, PAGES 69 THRU 76
PUBLIC RECORDS OF INDIAN RIVER
COUNTY, FLORIDA

N88° 56' 13"E
139.51'

N81° 12' 38"E
30.82'

S86° 13' 19"E
33.09'

S88° 42' 22"E
135.06'

N86° 23' 09"E
19.32'

S88° 46' 23"E
10.17'

S75° 08' 25"E
7.63'

SOUTH LINE OF TRACT M

65TH STREET

PARCEL A SHEET 2 OF 2



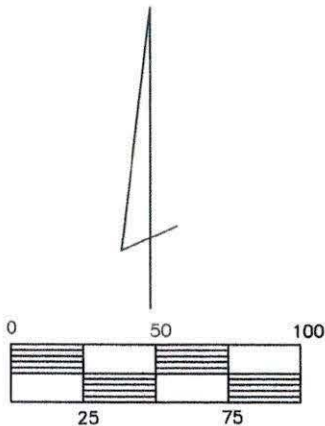

69TH STREET

MATCH LINE

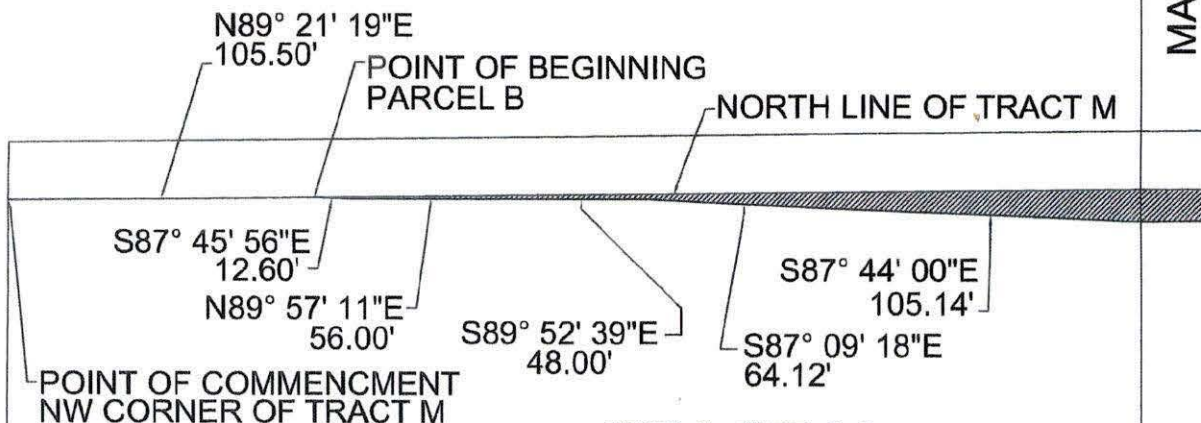

TRACT M

LOST TREE PRESERVE, PD
 PHASES 2 AND 3, AS RECORDED
 IN PLAT BOOK 31, PAGES 69 THRU 76
 PUBLIC RECORDS OF INDIAN RIVER
 COUNTY, FLORIDA

WEST LINE
 OF TRACT M

PARCEL B SHEET 1 OF 2

SRM 5/15/23
 Stephen R. Melchiori, PSM
 Florida Registration Number 5127
 Note: Sketch of Description, not a survey



MATCH LINE

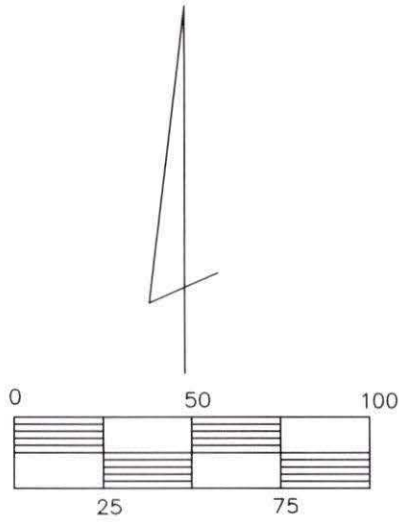

69TH STREET

S89° 21' 19"W
728.38'

NORTH LINE OF TRACT M

N85° 23' 04"E
103.08'

N87° 49' 46"E
44.52'

S86° 13' 59"E
113.10'

N82° 14' 05"E
50.89'

N78° 42' 58"E
22.69'

N88° 50' 33"E
109.91'

TRACT M

LOST TREE PRESERVE, PD
PHASES 2 AND 3, AS RECORDED
IN PLAT BOOK 31, PAGES 69 THRU 76
PUBLIC RECORDS OF INDIAN RIVER
COUNTY, FLORIDA

PARCEL B SHEET 2 OF 2



**Meets SJRWMD
Closure Standards**

CSH DATE: 06/26/2023

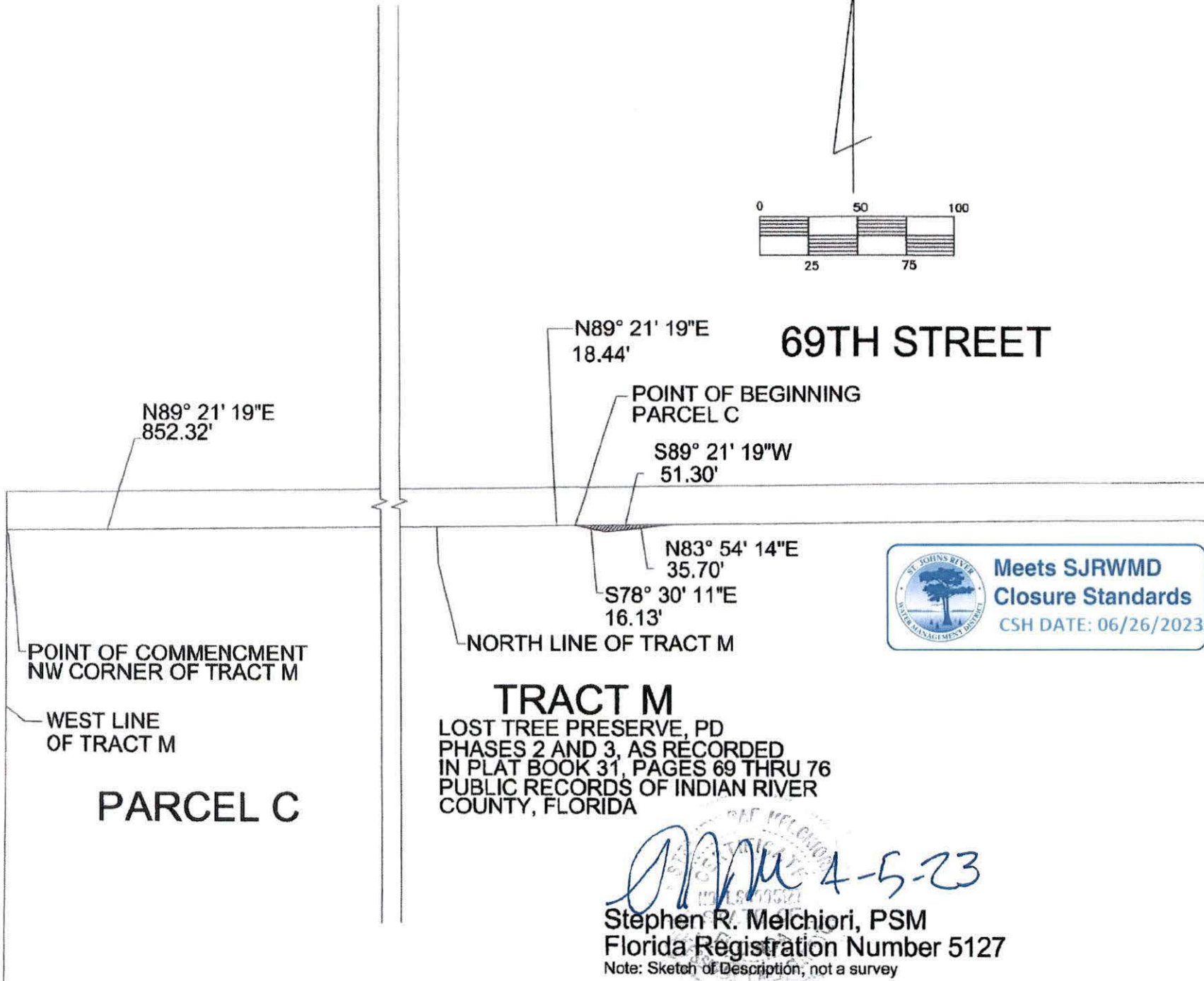
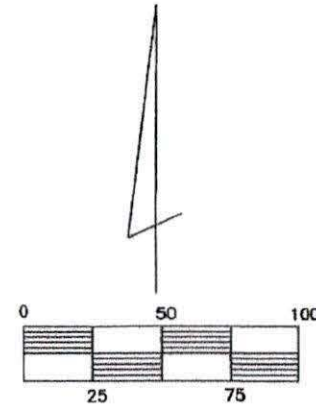

N89° 21' 19"E
852.32'

N89° 21' 19"E
18.44'

POINT OF BEGINNING
PARCEL C

S89° 21' 19"W
51.30'

N83° 54' 14"E
35.70'

S78° 30' 11"E
16.13'

NORTH LINE OF TRACT M

POINT OF COMMENCEMENT
NW CORNER OF TRACT M

WEST LINE
OF TRACT M

PARCEL C

69TH STREET

TRACT M

LOST TREE PRESERVE, PD
PHASES 2 AND 3, AS RECORDED
IN PLAT BOOK 31, PAGES 69 THRU 76
PUBLIC RECORDS OF INDIAN RIVER
COUNTY, FLORIDA

**Meets SJRWMD
Closure Standards**
CSH DATE: 06/26/2023

SM 4-5-23

Stephen R. Melchiori, PSM
Florida Registration Number 5127

Note: Sketch of Description, not a survey

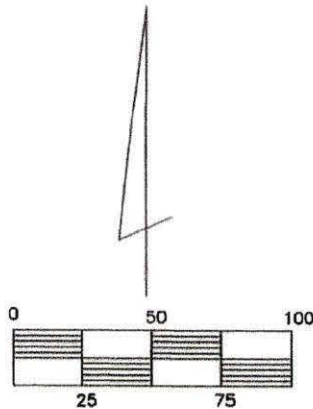

69TH STREET



N89° 21' 19"E
1,171.48'

S89° 21' 19"W
36.83'

POINT OF BEGINNING
PARCEL D

S84° 04' 40"E
16.71'

N83° 57' 25"E
20.32'

NORTH LINE OF TRACT M

TRACT M

LOST TREE PRESERVE, PD
PHASES 2 AND 3, AS RECORDED
IN PLAT BOOK 31, PAGES 69 THRU 76
PUBLIC RECORDS OF INDIAN RIVER
COUNTY, FLORIDA

POINT OF COMMENCEMENT
NW CORNER OF TRACT M

WEST LINE
OF TRACT M

PARCEL D

SRM 45-23
Stephen R. Melchiori, PSM
Florida Registration Number 5127
Note: Sketch of Description, not a survey

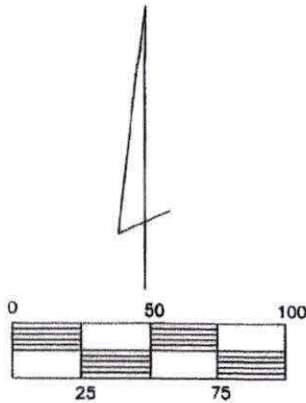

N89° 21' 19"E
1,256.98'

69TH STREET

POINT OF BEGINNING
PARCEL E

S89° 21' 19"W
65.35'

S84° 59' 07"E
34.77'

N82° 59' 32"E
30.94'

NORTH LINE OF TRACT M

POINT OF COMMENCEMENT
NW CORNER OF TRACT M

WEST LINE
OF TRACT M

PARCEL E

TRACT M

LOST TREE PRESERVE, PD
PHASES 2 AND 3, AS RECORDED
IN PLAT BOOK 31, PAGES 69 THRU 76
PUBLIC RECORDS OF INDIAN RIVER
COUNTY, FLORIDA

SRM 4-5-23

Stephen R. Melchiori, PSM
Florida Registration Number 5127

Note: Sketch of Description, not a survey



Exhibit 2

(the exchange parcel)

Parcel F
Area to be added to the Conservation Easement

A portion of Tract C, Lost Tree Preserve PD, Phase 1, as recorded in Plat Book 30, Pages 1 thru 8, Public Records of Indian River County, Florida; Commence at the northwest corner of said Tract C, said point also being the northeasterly corner of Tract B as depicted on said plat of Lost Tree Preserve PD, Phase 1. Said Tract B being a portion of the Conservation Easement recorded in Official Record Book 3134, Page 2422, Public Records of Indian River County, Florida; thence along the north boundary of said Tract C, S89°22'11"E, for a distance of 16.23' to the point of beginning;
thence continue S89°22'11"E, along said north line of said Tract C, for a distance of 8.46';
thence, S29°31'13"E, for a distance of 14.76'; thence, S26°34'56"E, for a distance of 17.29';
thence S29°22'34"E, for a distance of 10.51'; thence, S30°16'30"E, for a distance of 11.93';
thence, S41°43'54"E, for a distance of 13.73'; thence, S63°58'30"E, for a distance of 8.27';
thence, S07°21'48"W, for a distance of 28.34'; thence, S33°54'04"E, for a distance of 28.79';
thence S06°14'44"E, for a distance of 10.54'; thence, S35°45'41"E, for a distance of 9.60';
thence, S00°43'03"W, for a distance of 15.00'; thence, S28°40'13"E, for a distance of 21.19';
thence S21°36'36"E, for a distance of 19.00'; thence, S45°46'31"W, for a distance of 26.38';
thence, S72°35'20"W, for a distance of 24.18'; thence, S89°31'51"W, for a distance of 29.95';
thence, N73°47'28"W, for a distance of 14.06'; thence, N75°28'27"W, for a distance of 14.29';
thence S69°31'37"W, for a distance of 8.78'; thence, S53°49'03"W, for a distance of 23.37';
thence, N37°14'02"W, for a distance of 21.48'; thence, N63°54'26"E, for a distance of 39.15';
thence, S43°18'17"E, for a distance of 14.75'; thence, N47°03'21"E, for a distance of 54.42';
thence, N03°53'30"W, for a distance of 65.34'; thence, N11°17'13"W, for a distance of 45.75';
thence, N22°27'44"W, for a distance of 51.70' to the point of beginning. Said parcel contains 8,015 square feet more or less.

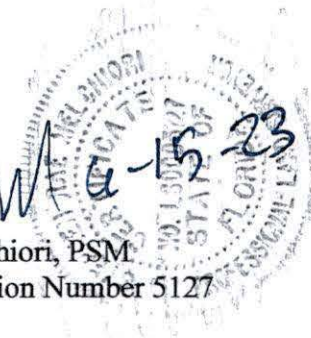

Stephen R. Melchiori, PSM
Florida Registration Number 5127



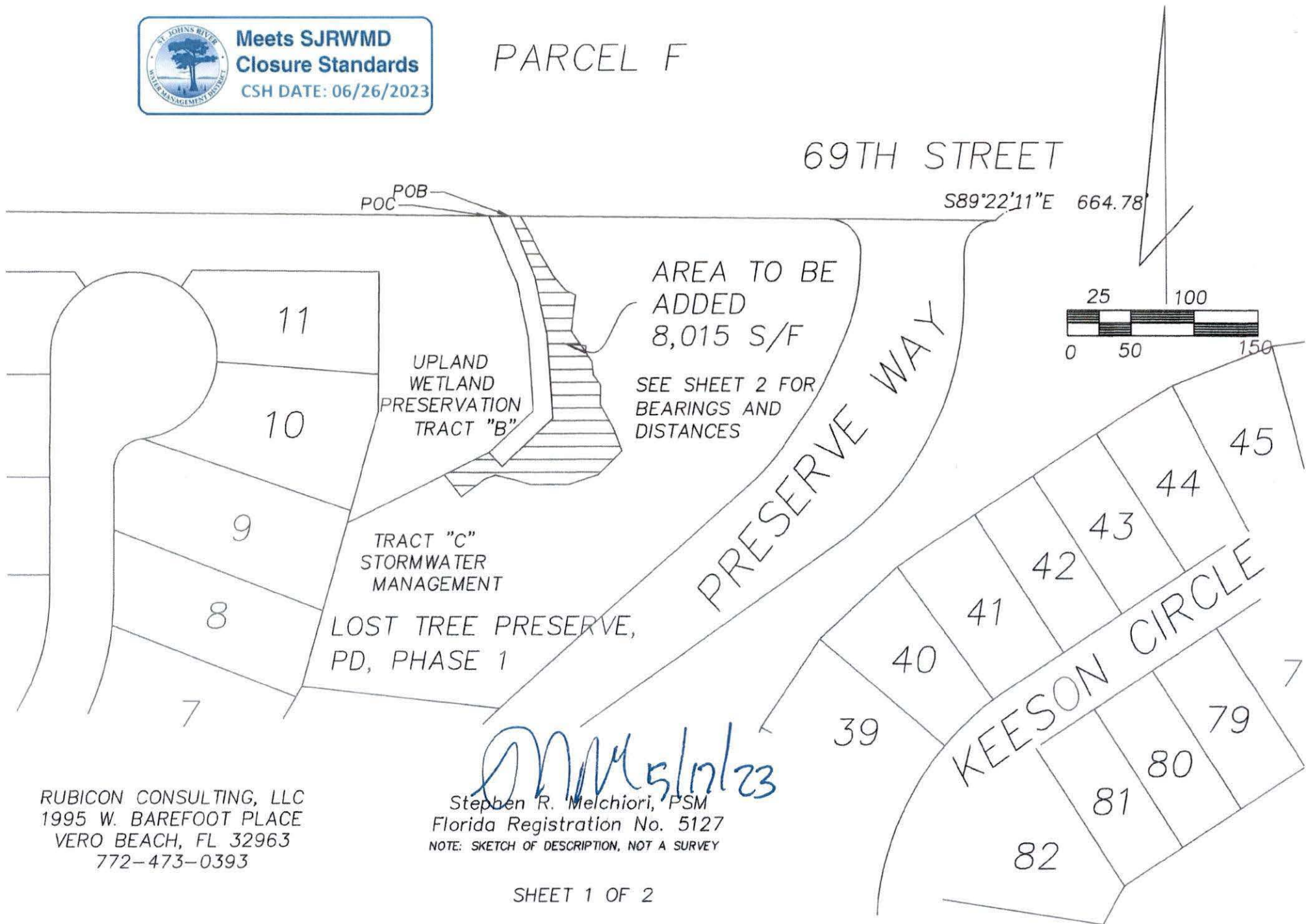

**Meets SJRWMD
Closure Standards**
CSH DATE: 06/26/2023

PARCEL F



RUBICON CONSULTING, LLC
1995 W. BAREFOOT PLACE
VERO BEACH, FL 32963
772-473-0393

SRM 5/17/23
Stephen R. Melchiori, PSM
Florida Registration No. 5127
NOTE: SKETCH OF DESCRIPTION, NOT A SURVEY

POC NE
CORNER
TRACT B

POB

PARCEL F

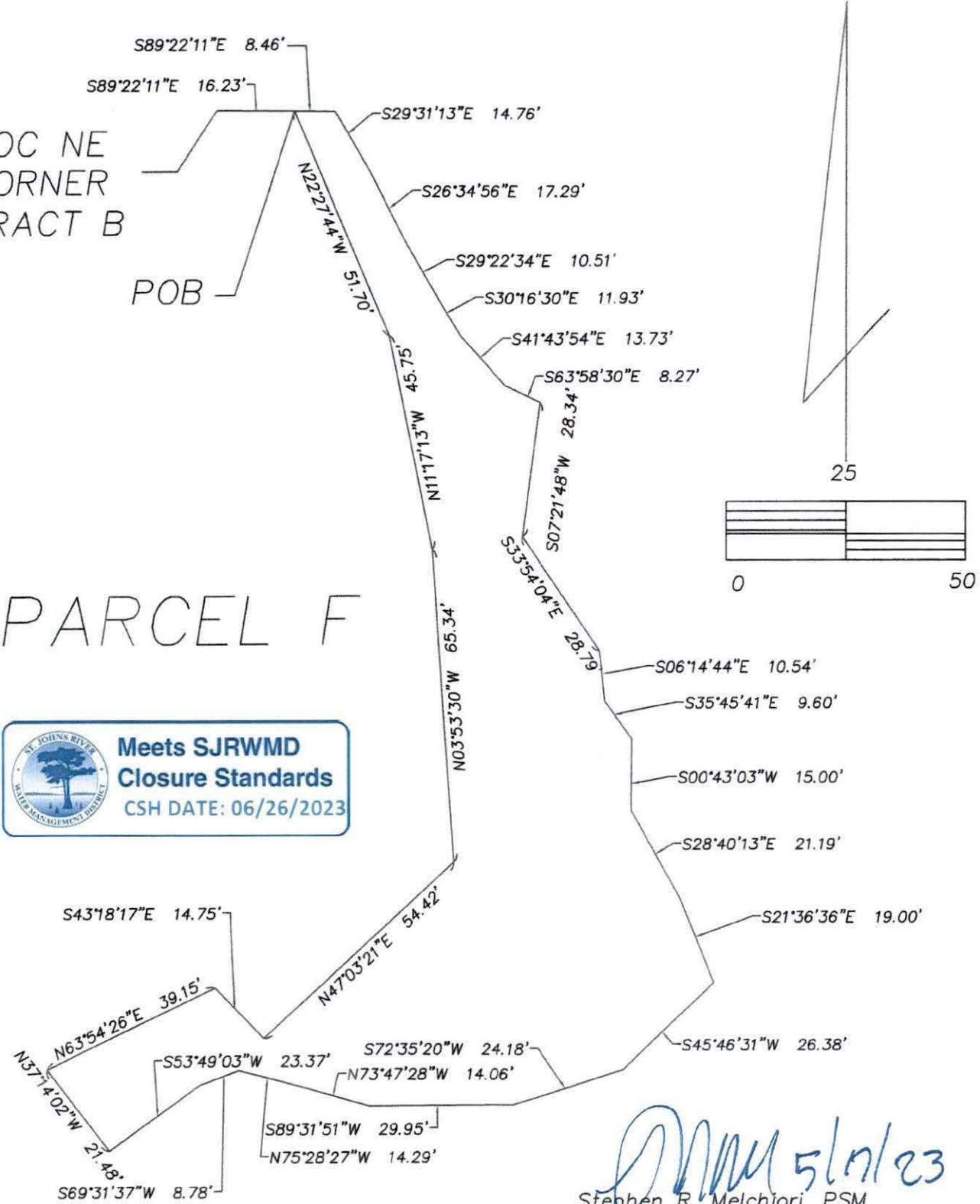

Stephen R. Melchiori
 Stephen R. Melchiori, PSM
 Florida Registration No. 5127
 NOTE: SKETCH OF DESCRIPTION, NOT A SURVEY

RUBICON CONSULTING, LLC
 1995 W. BAREFOOT PLACE
 VERO BEACH, FL 32963
 772-473-0393